

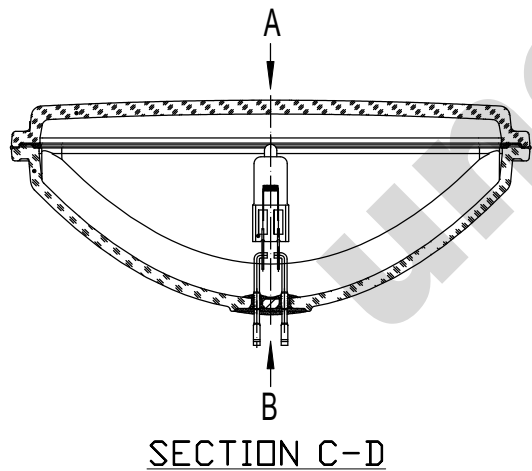

Since 1959

PART NO.	BASE TYPE	DESIGN VOLTS	DESIGN WATTS	APPROX. INITIAL MAX CP	BEAM SPREAD HOR. X VER. DEGREES	AVERAGE LIFE HOURS	REVISIONS			
							REV #	DESCRIPTION	DATE	APPROVED
H9405	2 LUGS RT. ANGLE	12.8	50	100,000	7 x 4	100	1	ISSUED	10/05/2016	RM

H9405 12.8V 50W

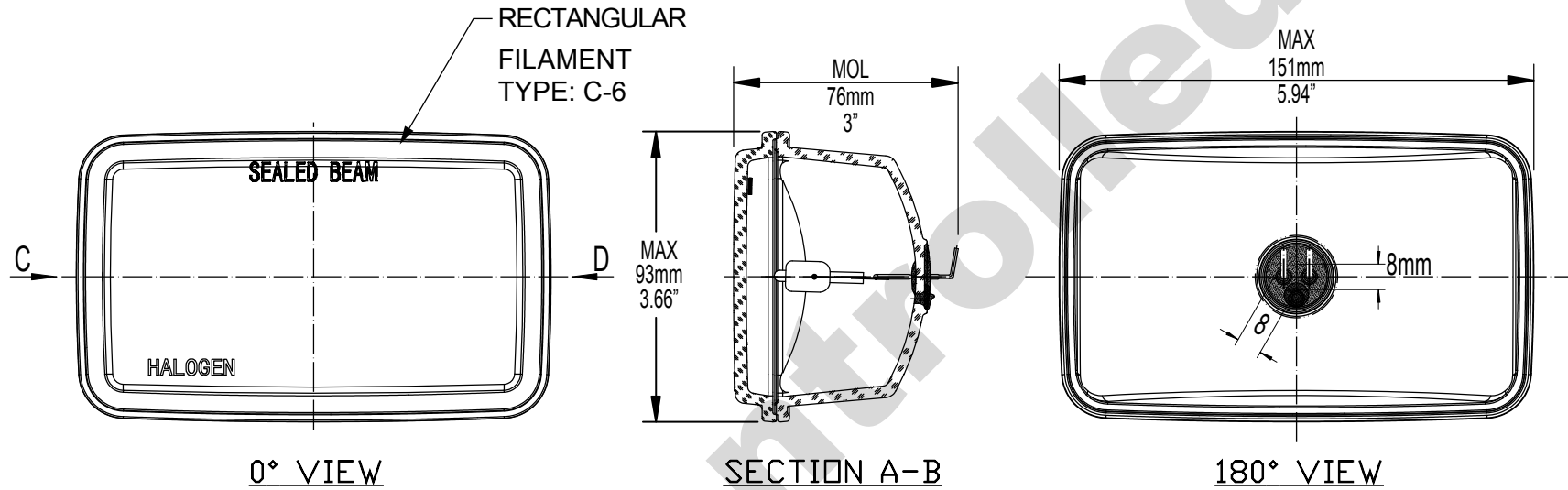

Note: Made according to SAE specifications

UNLESS OTHERWISE SPECIFIED: DIMENSIONS ARE IN INCHES TOLERANCES		CEC INDUSTRIES LTD			
DECIMALS	ANGULAR	599 BOND STREET		LINCOLNSHIRE, IL 60069	
.XX ± .05	± 0.5°				
.XXX ± .010					
FRACTIONAL	± 1/64				
DRAWN ROSE MEDINA	DATE 10/05/2016	TITLE SEAL BEAM H9405			
CHECKED	SIZE A	FSCM NO.	DWG NO. H9405	REV 1	
DESIGN	SCALE	PLOT SCALE	SHEET 1 OF 1		
MATERIAL	FILE H9405.pdf	DRAWING NOT TO SCALE			